

SANMOTION

3-PHASE STEPPING SYSTEMS

F3



Ver.2

SANYO DENKI

Ranges of stepping systems

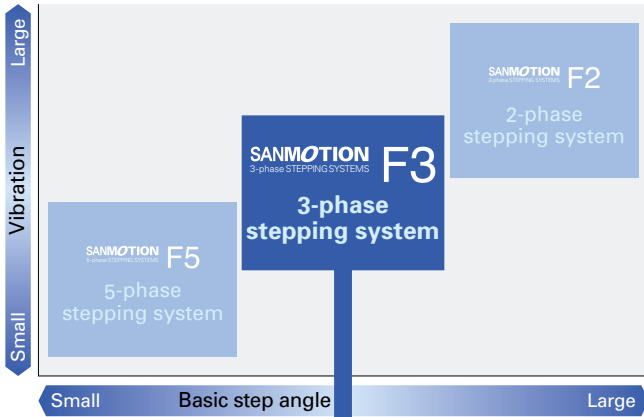

Ranges of 3-phase stepping motors

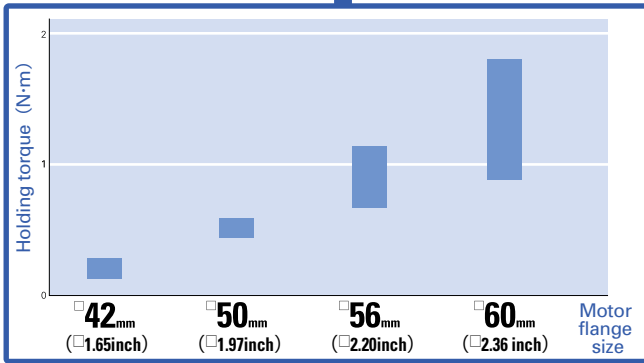

Set model

DC input

Standard model P.5

The standard set includes a F series driver and a H series motor.
(Contents of standard model :)
(driver, motor, connector)

Motor flange size

42	50	56	60
(1.65inch)	(1.97inch)	(2.20inch)	(2.36inch)

Compliance with international standards

The standard specification SANMOTION F series stepping driver complies with UL and EN safety standards.



Options

Ⓐ AC power cable

Driver side

Pin number	Color
1	Black
2	White

Model of cable	Length
PM-C02P0100-01	1 m (3.28 feet)

Ⓑ Stepping motor extension cable for 42 mm (1.65 inch)

Driver side

Pin number	Color
1	Red
2	White
3	Black

Model of cable	Length
PM-C03M0100-02	1 m (3.28 feet)

Applicable stepping motor
10H5332-03 □ 0 10H5333-03 □ 0

Ⓒ Stepping motor extension cable for 50 mm (1.97 inch)

Driver side

Pin number	Color
1	Red
2	White
3	Black

Model of cable	Length
PM-C03M0100-01	1 m (3.28 feet)

Applicable stepping motor
103H6332-03 □ 0 103H6333-03 □ 0
103H7332-03 □ 0 103H7333-03 □ 0
103H7832-03 □ 0 103H7833-03 □ 0

Ⓓ I/O signal cable

Driver side

Pin number	Color
1	
2	
3	
4	
5	
6	Blue
7	
8	
9	
10	
11	

Model of cable	Length
PM-C11S0100-01	1 m (3.28 feet)

System configuration

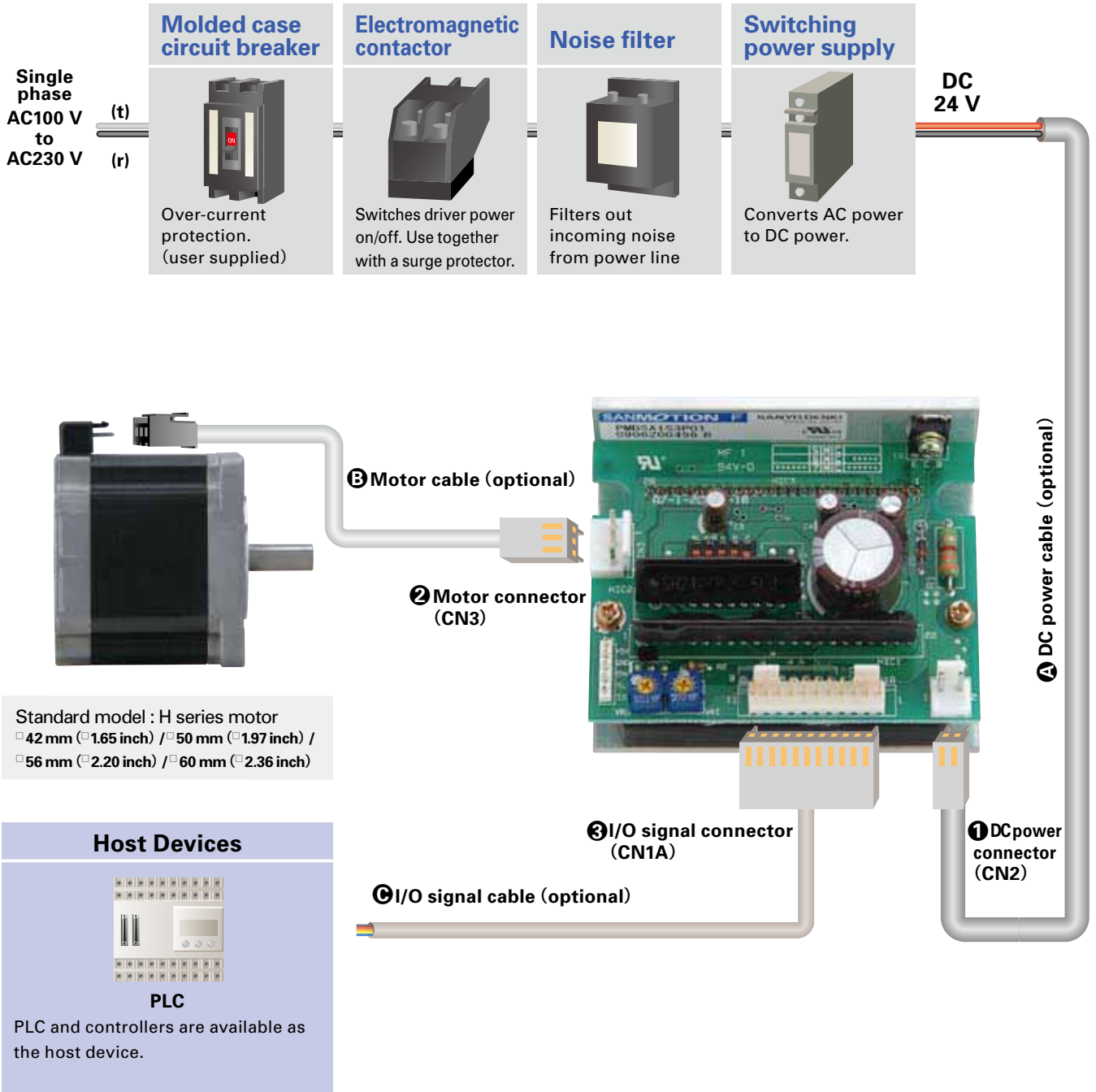

DC input

Stepping motor

Dimensions

Input / Output signal standard

HIC for stepping motor

① Connector sets

Model	Used for	Contents of set	Quantity	Manufacturer	Applicable wire size	Crimp tool number
① PM-AP-036	DC source (CN2)	Applicable housing : VHR-2N	1	J.S.TMfg.Co.,Ltd	AWG18 to 22	YC-160R
		Applicable contact : SVH-21T-P1.1	2			
② PM-AP-041 □ 42 mm (□ 1.65 inch)	Stepping motor (CN3)	Applicable contact : SVH-21T-P1.1	1	J.S.TMfg.Co.,Ltd	AWG22	YC-160R
		Applicable contact : 21T-P1.1	3			
		Applicable housing : HER-3-NATURAL	1			YC-260R
		Applicable contact : SHE-001T-P0.6	3			
② PM-AP-040 □ 50 mm (□ 1.97 inch) MIN.		Applicable housing : VHR-3N	2	J.S.TMfg.Co.,Ltd	AWG18 to 22	YC-160R
		Applicable contact : SVH-21T-P1.1	6			
③ PM-AP-039	I/O signals (CN1A)	Applicable housing : 5051-11	1	Modex Japan Co.,Ltd	AWG22 to 28	JHTR2262A
		Applicable contact : 2759PBG	11			JHTR2262J

Part number convention

The following set part number specifies a system with an F series driver (type code : PMDSA1S3P01) and a single shaft H series motor (type code : 103H7332-0340), □56 mm (□2.20 inch) square flange, and 53.8 mm (2.12 inch) motor length.

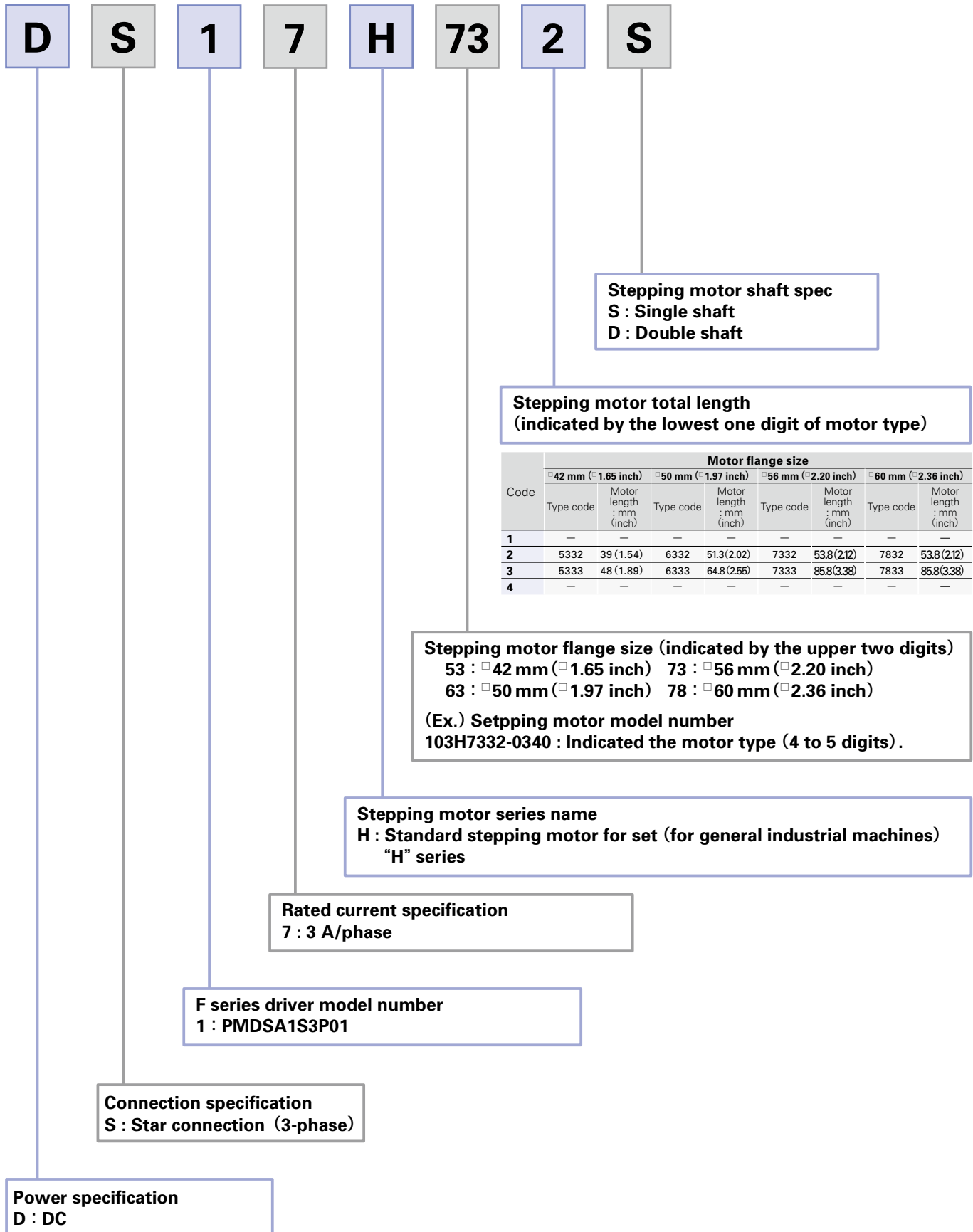

Combination list of 3-phase driver

System type	Motor flange size	Basic step angle	Set part number		Motor model number		Rated current
			Single shaft	Double shaft	Single shaft	Double shaft	
Standard model	□ 42 mm (□ 1.65 inch)	1.2°	DS17H532S	DS17H532D	103H5332-0340	103H5332-0310	3 A
		1.2°	DS17H533S	DS17H533D	103H5333-0340	103H5333-0310	3 A
	□ 50 mm (□ 1.97 inch)	1.2°	DS17H632S	DS17H632D	103H6332-0340	103H6332-0310	3 A
		1.2°	DS17H633S	DS17H633D	103H6333-0340	103H6333-0310	3 A
	□ 56 mm (□ 2.20 inch)	1.2°	DS17H732S	DS17H732D	103H7332-0340	103H7332-0310	3 A
		1.2°	DS17H733S	DS17H733D	103H7333-0340	103H7333-0310	3 A
	□ 60 mm (□ 2.36 inch)	1.2°	DS17H782S	DS17H782D	103H7832-0340	103H7832-0310	3 A
		1.2°	DS17H783S	DS17H783D	103H7833-0340	103H7833-0310	3 A

DC input

Stepping motor

Specifications of driver

Basic specifications	Model number		PMDSA1S3P01	
	Input source	Main power	DC24 V ± 10 %	
		Control power	—	
	Source current		3 A MAX.	
	Environment	Operating ambient temperature		0 to +50°C
		Conservation temperature		-20 to +70°C
		Operating ambient humidity		35 to 85 % RH (no condensation)
		Conservation humidity		10 to 90 % RH (no condensation)
		Vibration resistance		0.5G Tested under the following conditions, frequency range : 10 to 55 Hz, direction : along the X, Y, and Z axes, for 2 hours
		Impact resistance		Considering the NDS-C-0110 standard section 3.2.2 division "C", not influenced
		Withstand voltage		Not influenced when AC500 V is applied between power input terminal and cabinet for one minute
		Insulation resistance		10M Ω when measured with DC500 V megohmmeter between
	Mass (Weight)		0.14 kg (0.31 lbs)	
	Applied Standards	UL Standards	UL508C	
File No.		E179775		
Functions	Selection function		Auto current down, step angle, pulse input method (optional)	
I/O signals	Command pulse input signal		Photo coupler input method, input resistance 330 Ω Input signal voltage : H = 4.0 to 5.5 V L = 0 to 0.5 V Maximum input frequency : 50kpulse/s	
	Power down input signal		Photo coupler input method, input resistance 330 Ω Input signal voltage : H = 4.0 to 5.5 V L = 0 to 0.5 V	
	Rotation monitor output signal		Open collector output by photo coupler Output signal standard, Vceo = 30 V MAX., Ic = 5 mA MAX.	

Dimensions

Input / Output signal standard

HIC for stepping motor

Standard model

F series driver + H series motor

Motor flange size



Size	Motor flange size	□ 42 mm (□ 1.65 inch)	
	Motor length	39 mm (1.54 inch)	48 mm (1.89 inch)
Set part number	Single shaft	DS17H532S	DS17H533S
	Double shaft	DS17H532D	DS17H533D
Holding torque	N·m(oz·in)	0.196 (27.75)	0.265 (37.53)
Rotor inertia	$\times 10^{-4}$ kg·m ² (oz·in ²)	0.053 (0.29)	0.065 (0.36)
Mass (Weight)	kg (lbs)	0.3 (0.66)	0.38 (0.84)
Allowable thrust load	N (lbs)	10 (2.25)	10 (2.25)
Allowable radial load ^(Note1)	N (lbs)	26 (5.85)	25 (5.62)

(Note1) When load is applied at 1/3 length from output shaft edge.



DC24V

Operating current:
3A/phase

- Pull-out torque
 - - - Source current (load applied)
 - · · Source current (no load)
 - 1-division fs
 - 2-division fs
 - 1-division
 - 2-division
- fs: Maximum self-start frequency when not loaded

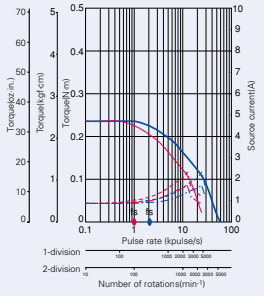
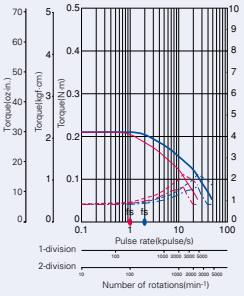

The data are measured under the drive condition of our company. The drive torque may vary depending on the accuracy of customer-side equipment.

Size	Motor flange size	□ 60 mm (□ 2.36 inch)
	Motor length	85.8 mm (3.98 inch)
Set part number	Single shaft	DS17H783S
	Double shaft	DS17H783D
Holding torque	N·m(oz·in)	1.68 (237.90)
Rotor inertia	$\times 10^{-4}$ kg·m ² (oz·in ²)	0.84 (4.59)
Mass (Weight)	kg (lbs)	1.34 (2.95)
Allowable thrust load	N (lbs)	20 (4.50)
Allowable radial load ^(Note1)	N (lbs)	85 (19)

(Note1) When load is applied at 1/3 length from output shaft edge.

DC24V

Operating current:
3A/phase

- Pull-out torque
 - - - Source current (load applied)
 - · · Source current (no load)
 - 1-division fs
 - 2-division fs
 - 1-division
 - 2-division
- fs: Maximum self-start frequency when not loaded

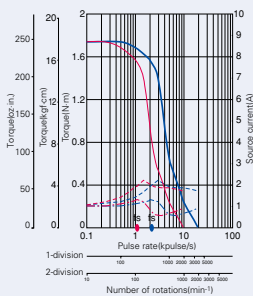

□ 50 mm (□ 1.97 inch)		□ 56 mm (□ 2.20 inch)		□ 60 mm (□ 2.36 inch)	
51.3 mm (2.02 inch)	64.8 mm (2.55 inch)	53.8 mm (2.12 inch)	75.8 mm (2.98 inch)	53.8 mm (2.12 inch)	53.8 mm (2.12 inch)
DS17H632S	DS17H633S	DS17H732S	DS17H733S	DS17H782S	DS17H782S
DS17H632D	DS17H633D	DS17H732D	DS17H733D	DS17H782D	DS17H782D
0.44 (62.31)	0.58 (82.13)	0.69 (97.71)	1.1 (155.77)	0.95 (134.53)	0.95 (134.53)
0.12 (0.66)	0.17 (0.93)	0.21 (1.15)	0.36 (1.97)	0.4 (2.19)	0.4 (2.19)
0.5 (1.10)	0.65 (1.43)	0.65 (1.43)	0.98 (2.16)	0.78 (1.72)	0.78 (1.72)
15 (3.37)	15 (3.37)	15 (3.37)	15 (3.37)	20 (4.50)	20 (4.50)
75 (16.87)	71 (15.97)	71 (15.97)	62 (13.95)	104 (23.4)	104 (23.4)

DC input

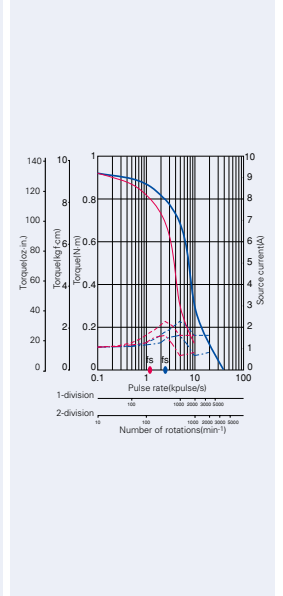
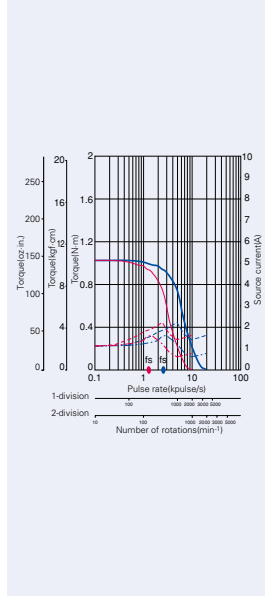
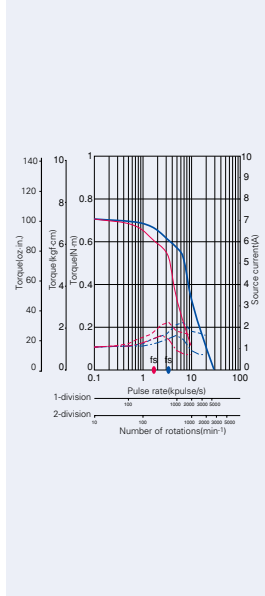
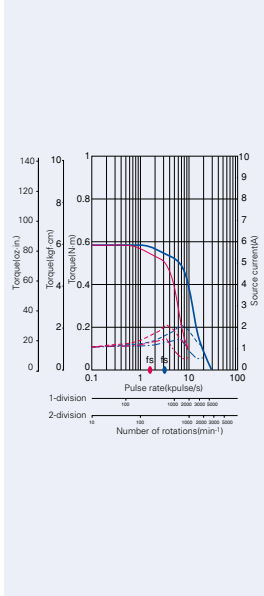
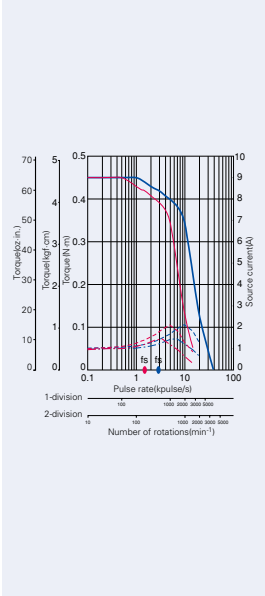

Stepping motor

Dimensions

Input / Output signal standard

HIC for stepping motor

Operation, connection, and function

Each section name of the driver

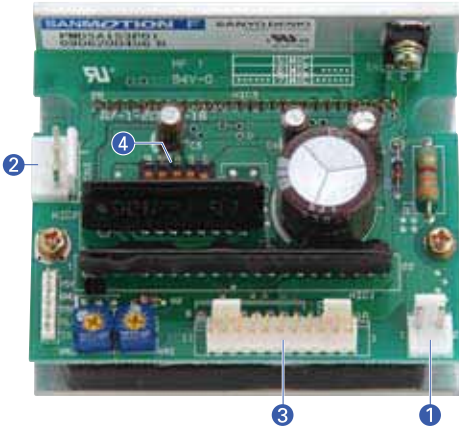

- ① DC source connector (CN2)
.....Connect the DC source.
- ② Stepping motor output connector (CN3)
.....Connect the stepping motor drive line.
- ③ I/O signal connector (CN1A)
.....Connect the I/O signal.
- ④ Function selection DIP switchpack (SL, F/R, A, B, C)
.....Select the function depending on your specification.

③ I/O signal function

Signal name (abbreviation)	Pin number (CN1A) PMDSA1S3P01	Function
Pulse input (CW)	1	Inputs the drive pulse for the rotation in the CW direction.
	2	
Pulse input (CCW)	3	Inputs the drive pulse for the rotation in the CCW direction.
	4	
Power down input (PD)	5	Inputting the PD signal turns off the current that flows through the stepping motor. Photo coupler input method : Internal photo coupler ON..... PD function enabled
	6	
Rotation monitor output (MON)	MON (collector) 7 MON (collector) 8	Indicates ON when the exciting phase is at the origin position. In the full-step, outputs once for every 6 pulses.

- The CW direction of the rotation of the stepping motor is the clockwise direction when viewing the stepping motor from the output axis side (flange side) .
The CCW direction is the counterclockwise direction when viewing the stepping motor from the output axis side (flange side) .

④ Function selection DIP switchpack

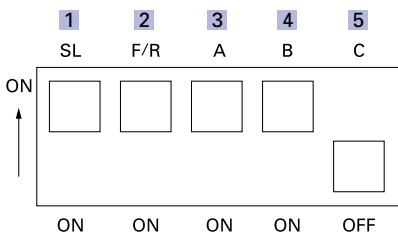

- The factory settings are shown in the figure above.
- Before changing the settings of the function selection DIP switches, turn off the source of the PM driver.

① SL (auto current down selection) Select the auto current down function.

SL	Automatic current reduction
ON	100 % of current rating when stopped
OFF	Approx. 50 % of current rating when stopped

Note 1) The temperature increase in the motor driver can be controlled by setting SL to OFF (approx. 50 % of the rated current) .

Note 2) The output torque when SL is OFF (approx. 50 % of the rated current) is approx. 50 % of that when SL is ON (100 % of the rated current) .

② F/R selection (Note) This switch is not used. Do not set it to OFF.

③ · ④ · ⑤ A, B, C (step angle setting) Set the step angle

DIP switch			Step angle	Number of drive pulses per one period of phase current
A	B	C		
ON	ON	OFF	Basic step angle 1/1 (1.2° pulse)	6
ON	OFF		Basic step angle 1/2 (0.6° pulse)	12
OFF	ON		Basic step angle 1/4 (0.3° pulse)	24
OFF	OFF		Basic step angle 1/8 (0.15° pulse)	48
OFF	OFF	ON	Basic step angle 1/16 (0.075° pulse)	48

- When the DIP switch "C" = "ON" (1/16 division), the internal circuit (stepping motor) operates at the rising edge and falling edge of the drive pulse. If the duty ratio of the drive pulse moves out of the adjustment significantly by 50 %, operation becomes unstable.

Input circuit configuration (CW and CCW Pulse input)

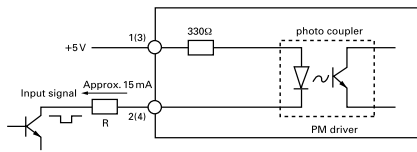

- Pulse duty : 50 % MAX.
- When the crest value of the input signal is 5 V, the external limit resistance R must be 0 Ω . When the crest value of the input signal exceeds 5 V, use the external limit resistance R to limit the input current to approximately 15 mA.

Input signal specifications

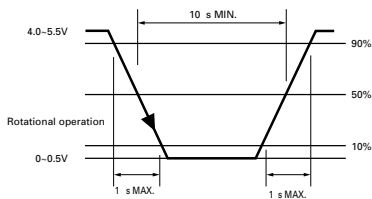

Timing of the command pulse

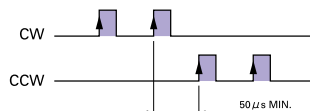

- The internal photo coupler turns ON within the pulse and, when the DIP switch "C" = "OFF", the internal circuit (stepping motor) operates at the rising edge of "ON" of the photo coupler.
- When applying the pulse to CW, turn OFF the CCW side internal photo coupler.
- When applying the pulse to CCW, turn OFF the CW side internal photo coupler.
- When the DIP switch "C" = "ON", the internal circuit (stepping motor) operates at the rising edge and falling edge of "ON" of the photo coupler.

Input circuit configuration (power down input)

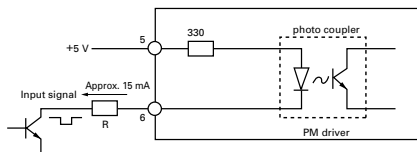

- When the crest value of the input signal is 5 V, the external limit resistance R must be 0 Ω . When the crest value of the input signal exceeds 5 V, use the external limit resistance R to limit the input current to approximately 15 mA.

Output circuit configuration (rotation moni for output)

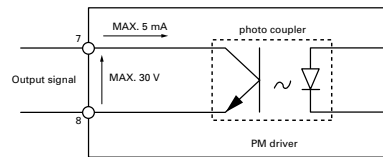

- Rotation monitor signal output signal
Contact type : Open collector output by photo coupler
Contact capacity : DC30 V, 5 mA MAX.

External wiring diagram

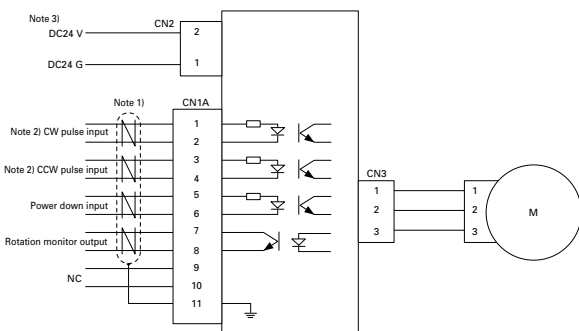

- (Note 1) Use twisted pair shielded cables.
- (Note 2) Switching between the "2-input mode (CW and CCW input method)" and the "Pulse and direction mode (CK, U/D)" is an optional function. For more information, contact us.
- (Note 3) Pay particular attention to the CN2 pin assignment.

Dimensions [Unit : mm (inch)]

PMDSA1S3P01 (photo coupler input method)

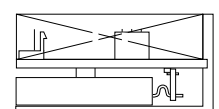
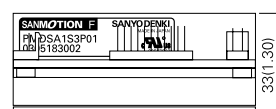
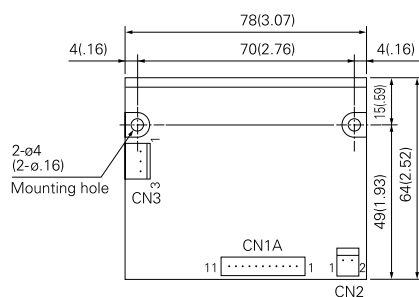



3-phase stepping motor

42 mm sq. (1.65 inch sq.)

103H533 □
1.2°/step HB type

Model	Holding torque at 2-phase energization	Rated current	Wiring resistance	Winding inductance	Rotor inertia	Mass (Weight)
Single shaft	Double shafts	[N · m (oz · in.) MIN.]	A/phase	Ω /phase	mH/phase	[×10 ⁻⁴ kg · m ² (oz · in ²)] [kg (lbs)]
103H5332-0340	-0310	0.196 (27.75)	3	0.84	0.5	0.053 (0.29) 0.3 (0.66)
103H5333-0340	-0310	0.265 (37.53)	3	0.94	0.5	0.065 (0.36) 0.38 (0.84)

Dimensions [unit : mm (inch)]

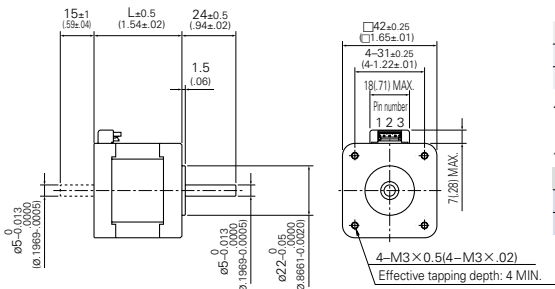

Set part number	Motor model number	Motor length (L)
DS17H532△	103H5332-03△0	39 mm (1.54 inch)
DS17H533△	103H5333-03△0	48 mm (1.89 inch)

△ indicates motor shaft specification

△ : Motor shaft spec

Motor shaft spec	Set part number	Motor model number
Single shaft	S	4
Double shafts	D	1

Pulse rate-torque characteristics

103H5332-0340

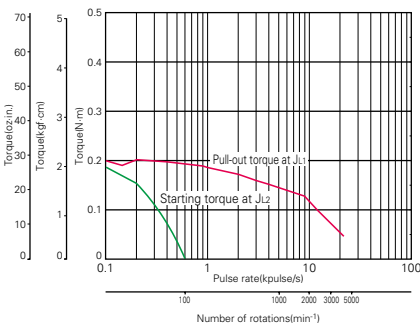

Constant current circuit
Source voltage : DC24 V · operating current : 3 A/phase,
2-phase energization (full step)
J₁₁=[0.94×10⁻⁴kg · m²(5.14oz · in²) use the rubber coupling.]
J₁₂=[0.8×10⁻⁴kg · m² (4.37oz · in²) use the direct coupling.]

103H5333-0340

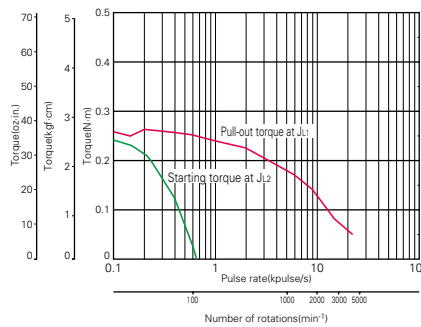

Constant current circuit
Source voltage : DC24 V · operating current : 3 A/phase,
2-phase energization (full step)
J₁₁=[0.94×10⁻⁴kg · m²(5.14oz · in²) use the rubber coupling.]
J₁₂=[0.8×10⁻⁴kg · m² (4.37oz · in²) use the direct coupling.]

3-phase stepping motor

50 mm sq. (1.97 inch sq.)

103H633 □
1.2°/step HB type

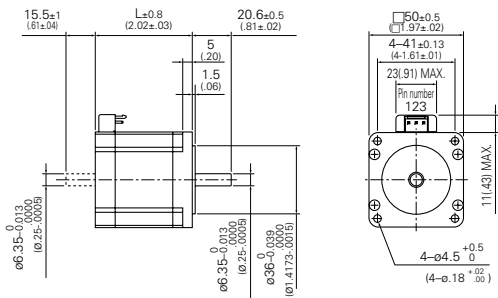

Model		Holding torque at 2-phase energization	Rated current	Wiring resistance	Winding inductance	Rotor inertia	Mass (Weight)
Single shaft	Double shafts	[N · m (oz · in.) MIN.]	A/phase	Ω /phase	mH/phase	[×10 ⁻⁴ kg · m ² (oz · in ²)]	[kg (lbs.)]
103H6332-0340	-0310	0.44 (62.31)	3	1.3	1.6	0.12 (0.66)	0.5 (1.10)
103H6333-0340	-0310	0.58 (82.13)	3	1.6	1.6	0.17 (0.93)	0.65 (1.43)

Dimensions [unit : mm (inch)]

Set part number	Motor model number	Motor length (L)
DS17H632△	103H6332-03△0	51.3 mm (2.02 inch)
DS17H633△	103H6333-03△0	64.8 mm (2.55 inch)

△ indicates motor shaft specification

△ : Motor shaft spec

Motor shaft spec	Set part number	Motor model number
Single shaft	S	4
Double shafts	D	1

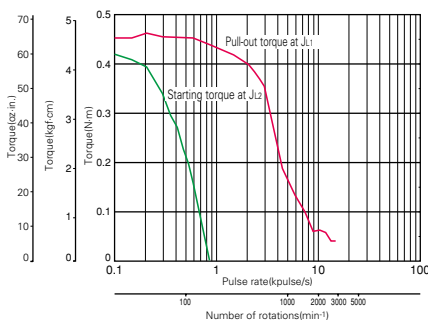
Pulse rate-torque characteristics**103H6332-0340**

Constant current circuit
Source voltage : DC24 V · operating current : 3 A/phase,
2-phase energization (full step)
 $J_{11}=[0.94 \times 10^{-4} \text{kg} \cdot \text{m}^2 (5.14 \text{oz} \cdot \text{in}^2)]$ use the rubber coupling.]
 $J_{12}=[0.8 \times 10^{-4} \text{kg} \cdot \text{m}^2 (4.37 \text{oz} \cdot \text{in}^2)]$ use the direct coupling.]

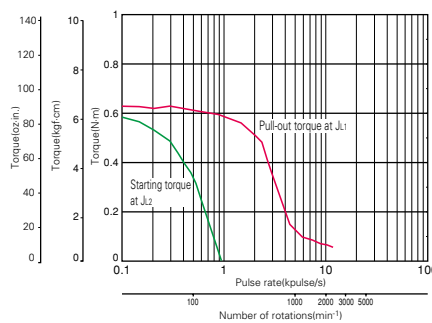
103H6333-0340

Constant current circuit
Source voltage : DC24 V · operating current : 3 A/phase,
2-phase energization (full step)
 $J_{11}=[0.94 \times 10^{-4} \text{kg} \cdot \text{m}^2 (5.14 \text{oz} \cdot \text{in}^2)]$ use the rubber coupling.]
 $J_{12}=[0.8 \times 10^{-4} \text{kg} \cdot \text{m}^2 (4.37 \text{oz} \cdot \text{in}^2)]$ use the direct coupling.]



3-phase stepping motor

56 mm sq. (2.20 inch sq.)

103H733 □
1.2°/step HB type

Model	Holding torque at 2-phase energization	Rated current	Wiring resistance	Winding inductance	Rotor inertia	Mass (Weight)	
Single shaft	Double shafts	[N · m (oz · in) MIN.]	A/phase	Ω /phase	mH/phase	[×10 ⁻⁴ kg · m ² (oz · in ²)] [kg (lbs)]	
103H7332-0340	-0310	0.69 (97.71)	3	1.4	1.8	0.21 (1.15)	0.65 (1.43)
103H7333-0340	-0310	1.1 (155.77)	3	1.7	2.4	0.36 (1.97)	0.98 (2.16)

Dimensions [unit : mm (inch)]

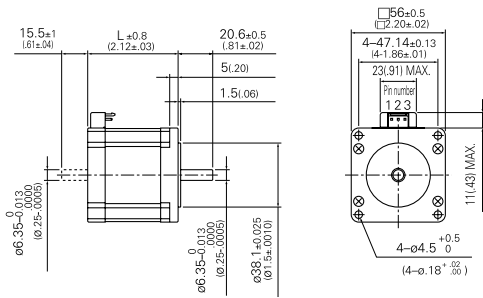

Set part number	Motor model number	Motor length (L)
DS17H732△	103H7332-03△0	53.8 mm (2.12 inch)
DS17H733△	103H7333-03△0	75.8 (2.98 inch)

△ indicates motor shaft specification

△ : Motor shaft spec

Motor shaft spec	Set part number	Motor model number
Single shaft	S	4
Double shafts	D	1

Pulse rate-torque characteristics

103H7332-0340

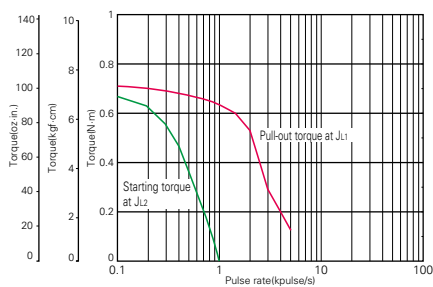

Constant current circuit
Source voltage : DC24 V · operating current : 3 A/phase,
2-phase energization (full step)
J₁=[0.94×10⁻⁴kg · m²(5.14oz · in²) use the rubber coupling.]
J₂=[0.8×10⁻⁴kg · m²(4.37oz · in²) use the direct coupling.]

103H7333-0340

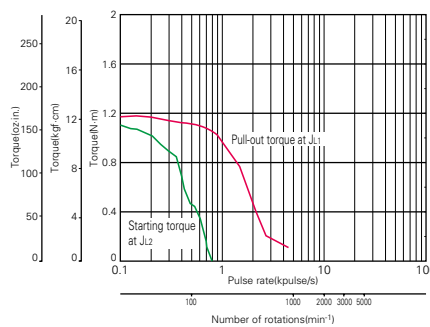

Constant current circuit
Source voltage : DC24 V · operating current : 3 A/phase,
2-phase energization (full step)
J₁=[2.6×10⁻⁴kg · m²(14.22oz · in²) use the rubber coupling.]
J₂=[2.6×10⁻⁴kg · m²(14.22oz · in²) use the rubber coupling.]

3-phase stepping motor

60 mm sq. (2.36 inch sq.)

103H783 □
1.2°/step HB type

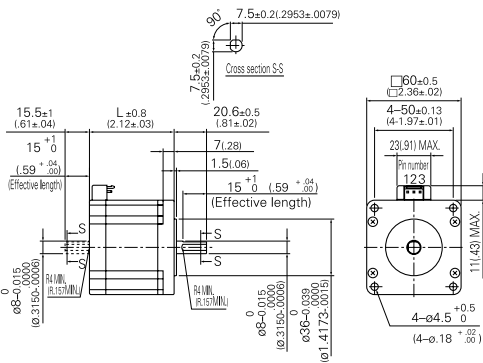

Model	Holding torque at 2-phase energization	Rated current	Wiring resistance	Winding inductance	Rotor inertia	Mass (Weight)	
Single shaft	Double shafts	[N · m (oz · in) MIN.]	A/phase	Ω /phase	mH/phase	[×10 ⁻⁴ kg · m ² (oz · in ²)] [kg (lbs)]	
103H7832-0340	-0310	0.95 (134.53)	3	1.5	1.8	0.4 (2.19)	0.78 (1.72)
103H7833-0340	-0310	1.68 (237.90)	3	2	3.2	0.84 (4.59)	1.34 (2.95)

Dimensions [Unit : mm (inch)]

Set part number	Motor model number	Motor length (L)
DS17H782△	103H7832-03△0	53.8 mm (2.12 inch)
DS17H783△	103H7833-03△0	85.8 (3.98 inch)

△ indicates motor shaft specification

△ : Motor shaft spec

Motor shaft spec	Set part number	Motor model number
Single shaft	S	4
Double shafts	D	1

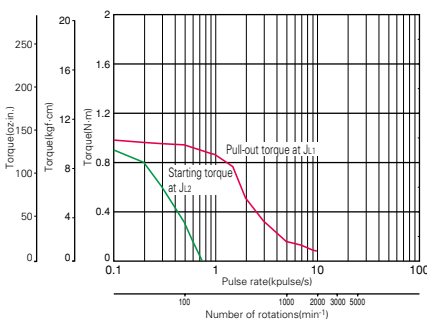
Pulse rate-torque characteristics**103H7832-0340**

Constant current circuit
Source voltage : DC24 V · operating current : 3 A/phase,
2-phase energization (full step)
J₁=[2.6×10⁻⁴kg·m² (14.22oz·in²) use the rubber coupling.]
J₂=[2.6×10⁻⁴kg·m² (14.22oz·in²) use the rubber coupling.]

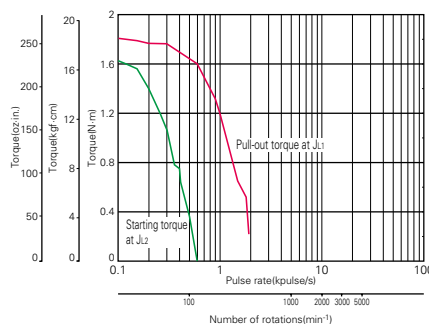
103H7833-0340

Constant current circuit
Source voltage : DC24 V · operating current : 3 A/phase,
2-phase energization (full step)
J₁=[7.4×10⁻⁴kg·m² (40.46oz·in²) use the rubber coupling.]
J₂=[7.4×10⁻⁴kg·m² (40.46oz·in²) use the rubber coupling.]

General specifications

	103H533 □	103H633 □	103H733 □	103H783 □
Insulation class	B species (130°)			
Insulation resistance	Not less than 100M Ω between winding and frame by DC500 V megger at normal temperature and humidity.			
Withstand voltage	Without abnormality when applying 50/60 Hz, 1000 V AC (500 V AC for 103H533□) for 1 minute (leakage current 1 mA) between winding and frame at normal temperature and humidity.			
Operating environment	Ambient temperature : -10 to +50°C			
	Ambient humidity : 20 to 90% (no condensation)			
Winding temperature rise	80 K MAX. (Based on Sanyo Denki standard.)			
Standing angle error	± 0.06°	± 0.06°	± 0.06°	± 0.06°
Axial play	0.075 mm (0.003 inch) MAX. Load : 9N (2lbs)	0.075 mm (0.003 inch) MAX. Load : 9N (2lbs)	0.075 mm (0.003 inch) MAX. Load : 9N (2lbs)	0.075 mm (0.003 inch) MAX. Load : 9N (2lbs)
Radial play (Note 1)	0.025 mm (0.001 inch) MAX. Load : 4.4N (1lbs)	0.025 mm (0.001 inch) MAX. Load : 4.4N (1lbs)	0.025 mm (0.001 inch) MAX. Load : 4.4N (1lbs)	0.025 mm (0.001 inch) MAX. Load : 4.4N (1lbs)
Shaft runout	0.025 mm (0.001 inch)			
Concentricity of mounting spigot relative to shaft	Φ 0.05 mm (0.002 inch)	Φ 0.075 mm (0.003 inch)	Φ 0.075 mm (0.003 inch)	Φ 0.075 mm (0.003 inch)
Perpendicularity of mounting surface relative to shaft	0.1 mm (0.004 inch)	0.1 mm (0.004 inch)	0.075 mm (0.003 inch)	0.075 mm (0.003 inch)

(Note1) When load is applied at 1/3 length from output shaft edge.

Internal connection and rotational direction

Internal connection

() Connector pin number

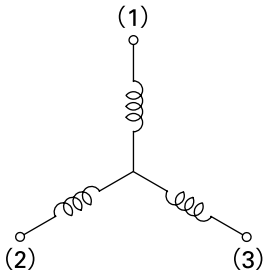

Direction of motor rotate

When DC-energized in the order below, the rotational direction must be counterclockwise viewed from the output axis side.

Type	Connector type pin number		
	(1)	(2)	(3)
Energization order	1	+	-
	2	+	-
	3	-	+
	4	-	+
	5	-	+
	6	-	+

Allowable radial load / thrust load

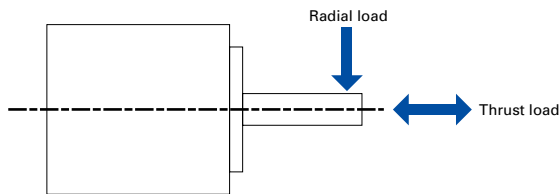

Frange size	Model number	Distance from end of shaft : mm (inch)				Thrust load : N(lbs)
		0 (0)	5 (0.2)	10 (2.25)	15 (3.38)	
Radial load : N (lbs)						
□ 42 mm (□ 1.65 inch)	103H53 □□	24 (5)	30 (6)	38 (8)	53 (11)	10 (2.25)
□ 50 mm (□ 1.97 inch)	103H63 □□	71 (15)	87 (19)	115 (25)	167 (37)	15 (3.37)
□ 56 mm (□ 2.2 inch)	103H73 □□	52 (11)	65 (14)	85 (19)	123 (27)	15 (3.37)
□ 60 mm (□ 2.36 inch)	103H783 □	70 (15)	87 (19)	114 (25)	165 (37)	20 (4.50)



3-phase stepping motor drive IC for universal controller

PMM3501

DC input

Stepping motor

Dimensions

Input / Output signal standard

HIC for stepping motor

Features

- Micro step sine wave drive driver
- Built-in current detection resistor
- Adopting MOSFET as the power drive device to reduce heat generation
- All-in-one package reducing the number of parts of the peripheral circuit
- 5 energization modes available with an external bit signal

Maximum ratings (Tc=25°)

Item	Symbol	Condition	Rating	Unit
Source voltage-1	V _{CC1 MAX.}	V _{CC2} = 0 V	30	V
Source voltage-2	V _{CC2 MAX.}	Without signal	7	V
Input voltage	V _{in MAX.}	Logic input terminal	7	V
Phase current	I _{O MAX.}	V _{CC2} = 5 V, Clock ≥ 100Hz	6	A
Board temperature during operation	T _{C MAX.}	No condensation at low temperature	0 to +105	°C
Joint temperature	T _{J MAX.}	—	+150	°C
Conservation temperature	T _{stg}	—	-40 to +125	°C

Recommended operating conditions (Ta=25°)

Item	Symbol	Condition	Rating	Unit
Source voltage-1	V _{CC1}	With signal	24 ± 10 %	V
Source voltage-2	V _{CC2}	With signal	5.0 ± 5 %	V
Input voltage	V _{IH}	—	0 to V _{CC2}	V
Phase current-1	I _{O1}	Without heat sink	1.7	A
Phase current-2	I _{O2}	T _c = 105°C, Clock ≥ 100Hz	4.4	A
Clock frequency	Clock	Pin 11 input frequency (pulse duty : 50 %)	0 to 120	kHz
Phase driver withstand voltage	V _{DSS}	I _b = 10 mA (T _c = 25°C)	60	V

External Figures [unit : mm (inch)]

Pin number	Name
1.	V _{CC1B}
2.	V _{CC1C}
3.	—
4.	UO
5.	WO
6.	VO
7.	Vz
8.	V _{CC1A}
9.	GND2
10.	V _{ref}
11.	Clock
12.	Mode A
13.	Mode B
14.	Hold
15.	CW/CCW
16.	Enable
17.	Reset
18.	Mode C
19.	GND1
20.	MOI
21.	V _{CC2}
22.	—
23.	UI
24.	VI
25.	WI
26.	—
27.	P.GNDA
28.	P.GNDB

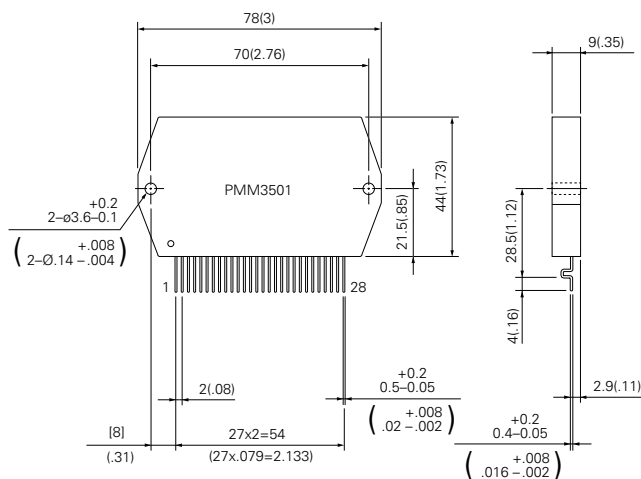

Electrical characteristics (Tc=25°, Vcc1=24 V, Vcc2=5 V)

Item	Symbol	Condition	Rating			Unit
			MIN.	Standard	MAX.	
Vcc2 source current	Icco	Enable = "L"	—	6.1	12	mA
Effective output current	I _{oe}	Each phase R/L = 2 Ω /6mH 2W2-3phase energization	0.92	1.03	1.14	A _{rms}
FET diode forward voltage	V _{df}	If = 1A (RL=23 Ω)	—	1.0	1.6	V
Output saturation voltage	V _{sat}	RL = 23 Ω	—	0.30	0.40	V
Output leak current	I _{ol}	RL = 23 Ω	—	—	0.1	mA
"H" level input voltage	V _{ih}	Pins 11 to 18	4.0	—	—	V
"L" level input voltage	V _{il}	Pins 11 to 18	—	—	1.0	V
Input current	I _{il}	Pins 11 to 18 = GND level Pull-up resistance : 20k Ω	115	250	550	μA
V _{ref} input voltage	V _{ih}	Pin 10	0	—	Vcc2 / 2	V
V _{ref} input current	I _i	Pin 10 = 2.5 V Internal resistance : 4k Ω	440	625	810	μA
"H" level MOI output voltage	V _{oh}	Pins 20-19 = 820k Ω	2.5	—	—	V
"L" level MOI output voltage	V _{ol}	Pins 21-20 = 1.6k Ω	—	—	0.4	V
PWM frequency	F _c	—	23	31	39	kHz

Function of each terminal

Function of each terminal	Function	Input condition for operation
V _{ref}	Motor current setting input	—
Clock	Pulse input for motor drive	Mode C = "H" : Rising edge operation Mode C = "L" : Rising edge and falling edge operation
Hold	Pause input	Hold = "L" level
CW/CCW	Motor rotational direction setting input	"H" level = CW rotation "L" level = CCW rotation
Enable	Power off input	Enable = "L" level
Reset	System reset	Reset = "L" level
MOI	Rotation monitor output	H level output once for each phase current period

Energization mode table

Input Mode A	Input Mode B	Input Mode C	Condition energization mode	1 step angle (degree)	Basic step division
L	L	H	2EX	1.2	1
L	H	H	2-3EX	0.6	2
H	L	H	W2-3EX	0.3	4
H	H	H	2W2-3EX	0.15	8
H	H	L	4W2-3EX	0.075	16

- When Mode C = "L", 1 step operation is performed for each rising edge and falling edge of the Clock pulse. If the duty ratio of the drive pulse moves out of the adjustment significantly by 50 %, operation becomes unstable.

Example of Application Circuit

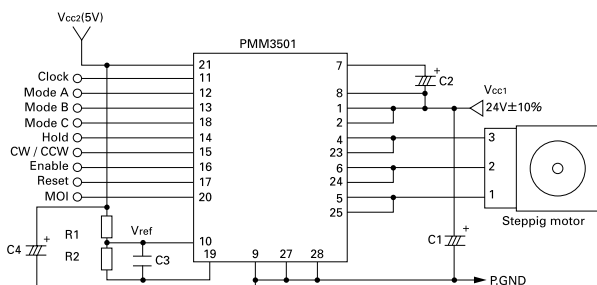

Recommended circuit part constants

C1	C2	C3	C4
470 μ F	6.8 μ F	0.1 μ F	10 μ F

- For the R1 and R2 constants, determine the V_{ref} voltage according to the following equation.
V_{ref}(V) = motor current adjustment value(A/phase) x 0.41
Notice that 100Ω is recommended for R2 due to the configuration of the internal circuit of the PMM3501.
- Place the GND side of the source by-pass capacitor of Vcc1(C1) as close to pins 27 and 28 as possible to reduce noise.
- Set "RESET" to High 10 μsecs after "+5 V" rises above "+4.5 V", as shown in Fig 1. When turning on the power with "ENABLE" set to Low, set "RESET" to High after "+24 V" rises completely.

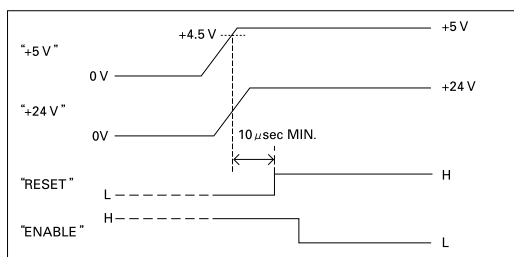

Fig1

Safety Consideration

The drivers and stepping motors are the products designed to be used for the general industrial devices.

When using those, pay enough attention to the following points.

- Read thoroughly the Operation Manual prior to placement, assembly and/or operation in order to use the product properly.
- Refrain from modifying or processing the product in any way.
- Consult with the distributor or professional experts for placement or maintenance services of the product.
- In case of the following uses of the product, contact with us for the special care required to the operation, maintenance and management such as multiplexing the system, installing an emergency electric generator set, or so forth.

- 1 Use for the medical devices concerned with a fatal accident.
- 2 Use for trains, elevators, and so forth that are likely to cause an accident resulting in injury, damage or death.
- 3 Use in the computer system highly influential to the social life or the public systems.
- 4 Use in other devices highly influential to maintaining the human safety or the public functions.

In addition to the above, consult with us for use in such a vibration environment as automobile or transportation.

Read the Operation Manual thoroughly prior to the use (placement, operation, maintenance and inspection) to put the product in use properly.

Make yourself knowledgeable and familiarize with the devices, safety issues and cautions before handling the product.

After reading the Operation Manual or the like, keep it in the place where the users can refer to whenever necessary.

Indication by (Warning Label) on the product

Either or all of the following indications are given by the Warning Labels depending on the type of the driver or stepping motor.



This label is stuck near the high voltage part such as the electrically charged or cover-protected section, warning that the place where it is likely to cause an electric shock.



This label is stuck on the place where the driver or stepping motor body should be easily acknowledged, warning that it is likely to cause burns from high temperature.



必ず正しく接地を
接続して下さい
Use proper
grounding
techniques.

This label is stuck near the GND terminals of the driver or stepping motor for which grounding is required, suggesting that the terminals should be actually grounded.



危険
WARNING
感電注意
May Cause
electric shock

This label is stuck for the driver or stepping motor to which the power source is applied in the voltage exceeding the safety standard, drawing attention against the electric shock.

Safety ranks of the cautions

Following four ranks are provided.



DANGER Improper operations or use is most likely to result in serious injury or death.



CAUTION Improper operations or use is likely to result in average or minor injury, or in property damage.

In spite of the cautions with the $\triangle_{\text{CAUTION}}$ CAUTION label, it may cause serious results. Either the contents of the labels is describing important cautions to be followed inevitably.



PROHIBITED Indicates what shall not be done.



COMPULSORY Indicates what shall be done.

DANGER

< General matters >

1. Do not use the product in an explosive, flammable or corrosive atmosphere, watery place or near a combustible material. Doing so may cause injury or fire.
2. Have a person with expert knowledge for performing the transportation, placement, wiring, operation, maintenance or inspection of the product. Without such knowledge, it may cause an electric shock, injury or fire.
3. Do not work for wiring, maintenance servicing or inspection with the electric power on. Perform either of those five minutes after turning the power off, or otherwise, it may cause an electric shock.
4. When the protective functions of the product is activated, turn the power off immediately and eliminate the cause. If continuing the operation without eliminating the cause, the product may operate improperly and cause injury or a breakdown of the system devices.
5. Stepping motor may run out of order at the operating and stopping occasions, depending on the magnitude of the load. Put the product into use after confirming with the adequate trial test operation in the maximum load conditions that the product performs reliable operation. Doing otherwise may cause a breakdown of the system. (Should the product run out of order in the use to drive upward/downward, it may cause a fall of the load.)
6. Do not touch the internal parts of the driver. Doing so may cause an electric shock.

< Wiring >

7. Do not connect the stepping motor directly with the commercial power outlet. Doing so may cause an electric shock, injury or fire. The power shall be supplied to the stepping motor through the driving circuit.
8. Use the electric power source within the rated input voltage. Using otherwise may cause fire or an electric shock.
9. Connect the driver and stepping motor to the ground. Using without grounding may cause an electric shock.
10. Do not harm, forcibly put a stress, or load a heavy article on the cable or get it caught between the articles. Doing so may cause an electric shock.
11. Perform wiring with the power cable as instructed by the wiring diagram or the Operation Manual. Doing otherwise may cause an electric shock or fire.

< Operation >

12. Be sure not to touch the rotating part of the stepping motor during its operation. Touching it may cause injury.
13. Neither reach or touch the electric terminals while electric power is on. Doing so may cause an electric shock.
14. Never disconnect any of the connectors while electric power is on. Doing so may cause an electric shock and corruption.

< General matters >

1. Prior to placement, operation, maintenance servicing or inspection, be sure to read the Operation Manual and follow the instructions to perform those. Failure to follow the instructions may cause an electric shock, injury or fire.
2. Do not use the driver or the stepping motor outside the specified conditions. Doing so may cause an electric shock, injury or fire.
3. Do not insert a finger or a thing into the opening of the product. Doing so may cause an electric shock, injury or fire.
4. Do not use the damaged driver or stepping motor. Doing so may cause injury, fire or the like.
5. Use the driver and stepping motor in the designated combination. Using otherwise may cause fire or a trouble.
6. Be careful that the temperature rises in the operating driver, stepping motor or peripheral devices. Failure to be careful may cause a burn.

< Unpacking >

7. Unpack while confirming the ceiling. Failure to do so may cause injury.
8. Confirm if the product is the one having been ordered. Installing an incorrect product may cause a breakdown.

< Wiring >

9. Do not perform measurement of the insulation resistance or withstand insulation voltage of the product. Doing so may cause a breakdown. Instead, contact with us for such inspection.
10. Perform wiring conforming to the technical standards of electric facility or the internal rule. Doing otherwise may cause burning or fire.
11. Ensure that wiring has been correctly done. Operating without correct wiring may cause the stepping motor to run out of control and result in injury.
12. Take insulation process for the attached condenser or the external resistance connection terminals. Failure to do so may cause an electric shock.

< Placement >

13. Do not climb or attach a heavy article on the product. Doing so may cause injury.
14. Neither block nor stuff the aspiration/exhaust vent with a foreign particle. Doing so may cause fire.
15. Follow the instructions for the direction to place. Failure to do so may cause a trouble.
16. Keep a distance as instructed by the Operation Manual for the driver from the inner surface of the control console or other devices. Failure to do so may cause a trouble.
17. Place the product with a great care so as to prevent from the danger such as a tumble or a turnover.

CAUTION

18. Mount the product on an incombustible material such as metal. Doing otherwise may cause fire.
19. Confirm the rotating direction before connecting with the mechanical device. Failure to do so may cause injury or a breakdown.
20. Do not touch the motor output spindle (including the key slot and gears) with a bare hand. Doing so may cause injury.

< Operation >

21. The stepping motor is not equipped with any protective device. Take protective measures using an over-current protective relay, a ground fault interrupter, a protective device from excess temperature, and an emergency stopping device. Failure to do so may cause injury or fire.
22. Do not touch the product for a period after the power is on or has been turned off, since the driver and stepping motor remain in the high temperature. Doing so may cause burns. Especially the temperature rises considerably of the stepping motor depending on the operating conditions. Use the motor on the condition so that its surface temperature becomes 100°C or under.
23. Stop the operation immediately when an emergency occurs. Failure to do so may cause an electric shock, injury or fire.
24. Do not change adjustment to an extreme, for such a change results in the unstable operation. Doing so may cause injury.
25. When conducting the trial operation, make the stepping motor fixed firmly, and confirm the operation by disconnecting with the mechanical system before connecting with it. Failure to do so may cause injury.
26. When the alarm has been activated, eliminate the cause and ensure the safety to resume operation. Failure to do so may cause injury.
27. When the electric power recovers after the momentary interruption, do not approach the devices because the system may re-start operation by itself. (Set the system so as to secure the safety even when it re-start on such occasion.) Failure to do so may cause injury.
28. Confirm that the electric power supply is all proper conforming to the specifications. Failure to do so may cause a trouble.
29. The brake mechanism of the motor with the electro-magnetic brake is to hold the movable section and the motor position. Do not use it as a safety measure, or doing so may cause the breakdown of the system.
30. Fix the key firmly when operating the motor with key individually. Failure to do so may cause injury.

< Maintenance services >

31. Be careful when performing maintenance services or inspection about the temperature which rises highly in the driver and stepping motor frame. Failure to do so may cause burns.
32. It is recommended to replace the electrolytic condenser of the driver with a new one for securing the preventive measure after using for 5 years, the expected life in the average 40°C. The expected life of the fuse and cooling fan motor is 10 years in the average 40°C. Thus, the periodical replacement is recommended.
33. Contact with us for repair. If the product is disassembled by the user, it may put it out of action.

< Transportation >

34. Handle the product with care during transportation so as to prevent from the danger such as a tumble or a turnover.
35. Do not hold with the cable or the motor spindle. Doing so may cause a trouble or injury.

< Retirement >

36. When scrapping the driver or stepping motor, treat it for the general industrial waste.

PROHIBITED

< Storage >

1. Avoid the place exposed to rain or water drops, or in an environment with hazardous gas or liquid for storing the product. Failure to do so may cause a trouble.

< Maintenance services >

2. Do not assemble or repair the product. Doing so may cause fire or an electric shock.

< General matters >

3. Do not remove the rating plate.

COMPULSORY

< Storage >

1. Store the product within the specified conservation temperature and humidity in the place not exposed to the sun beam.

2. If the driver has been stored for a long period (3 years or longer for a guide), consult with us. The capacitance may have decreased with the electrolytic condenser due to the long period storage, and it may cause a trouble.

< Operation >

3. Install an external emergency stop circuit to turn the power off for the instant halt of operation.
4. Put the product into operation in the specified ambient temperature and humidity.

< Transportation >

5. Excess loading of the product on the carrier may cause the load to fall in pieces. Follow the instructions given outside the package.

Inquiry Check Sheet

Please provide the following information when placing an order or making an inquiry.
Also feel free to include any questions that require our attention.

Company Name: _____
 Department: _____
 Telephone : _____
 Fax: _____
 1) Application: _____
 2) Name of Machinery: _____
 3) Number of Units: _____

Date: _____
 To contact us: _____
 Phone: +81 3 3917 5157
 Fax: +81 3 3917 0643

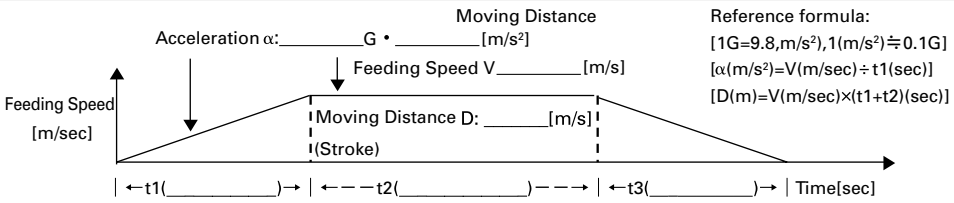
Item	Contents																																																																																																
1	Name of target equipment Equipment name, category (transport, processing, test, other)																																																																																																
2	Name of servo axis Axis name, axial mechanism (horizontal/vertical), brake mechanism (yes/no)																																																																																																
3	Current condition of above axis Manufacturer Name () Series Name () Motor Capacity () Hydraulic, Mechanical, or New System ()																																																																																																
4	Positioning accuracy ± mm / ± μm																																																																																																
5	Operation pattern  <p>Reference formula: $[1G=9.8, m/s^2], 1(m/s^2) \approx 0.1G]$ $[\alpha(m/s^2)=V(m/sec) \div t1(sec)]$ $[D(m)=V(m/sec) \times (t1+t2)(sec)]$</p>																																																																																																
6	Mechanism Ball-screw/screw-rotation type (horizontal), ball-screw/nut-rotation type (horizontal), rack and pinion (horizontal), belt/chain (horizontal), rotary table, roll feed, instability																																																																																																
7	Mechanical structure <table border="0" style="width:100%; border-collapse: collapse;"> <tr> <td style="width:33%;">WT (table mass)</td> <td style="width:10%;">kg</td> <td style="width:33%;">WL (work mass)</td> <td style="width:10%;">kg</td> <td style="width:14%;">WA (mass of other drive parts)</td> <td style="width:10%;">kg</td> </tr> <tr> <td>WR (rack mass)</td> <td>kg</td> <td>WB (belt/chain mass)</td> <td>kg</td> <td>WC (counterbalance mass)</td> <td>kg</td> </tr> <tr> <td>Fa (external force in axial direction)</td> <td>N</td> <td>Fb (ball-screw preload)</td> <td>N</td> <td>T (roll pushing force)</td> <td>N</td> </tr> <tr> <td>Dr1 (drive-side roll diameter)</td> <td>mm</td> <td>Dr2 (follower-side roll diameter)</td> <td>mm</td> <td></td> <td></td> </tr> <tr> <td>Lr1 (drive-side roll length)</td> <td>mm</td> <td>Lr2 (follower-side roll length)</td> <td>mm</td> <td>G (reduction ratio)</td> <td></td> </tr> <tr> <td>JG (speed-reducer inertia)</td> <td>kg·m²</td> <td>JC (coupling inertia)</td> <td>kg·m²</td> <td></td> <td></td> </tr> <tr> <td>JN (nut inertia)</td> <td>kg·m²</td> <td>JO (other motor-axis conversion inertia)</td> <td>kg·m²</td> <td></td> <td></td> </tr> <tr> <td>Db (ball-screw diameter)</td> <td>mm</td> <td>Lb (ball-screw axial length)</td> <td>mm</td> <td>Pb (ball-screw lead)</td> <td>mm</td> </tr> <tr> <td>Dp (pinion/pulley diameter)</td> <td>mm</td> <td>Lp (pinion axial length)</td> <td>mm</td> <td>Tp (pulley thickness)</td> <td>mm</td> </tr> <tr> <td>Dt (table diameter)</td> <td>mm</td> <td>Dh (table-support diameter)</td> <td>mm</td> <td>LW (load shift from axis)</td> <td>mm</td> </tr> <tr> <td>Ds (table shaft diameter)</td> <td>mm</td> <td>Ls (table shaft length)</td> <td>mm</td> <td></td> <td></td> </tr> <tr> <td>ρ (specific gravity of ball-screw/pinion/pulley/table-shaft material)</td> <td></td> <td></td> <td>kg/cm³</td> <td></td> <td></td> </tr> <tr> <td>μ (friction coefficient between sheet and sliding-surface/support-section/roll)</td> <td></td> <td>ρ1 (specific gravity of roll-1 material)</td> <td></td> <td></td> <td>kg/cm³</td> </tr> <tr> <td>ρ2 (specific gravity of roll-2 material)</td> <td></td> <td>κ (internal friction coefficient of preload nut)</td> <td></td> <td></td> <td></td> </tr> <tr> <td>η (mechanical efficiency)</td> <td></td> <td>JL (load inertia of motor-axis conversion)</td> <td></td> <td></td> <td>kg·m²</td> </tr> <tr> <td>TF (friction torque of motor axis conversion)</td> <td></td> <td>N·m</td> <td></td> <td>TU (imbalance torque of motor axis conversion)</td> <td>N·m</td> </tr> </table>	WT (table mass)	kg	WL (work mass)	kg	WA (mass of other drive parts)	kg	WR (rack mass)	kg	WB (belt/chain mass)	kg	WC (counterbalance mass)	kg	Fa (external force in axial direction)	N	Fb (ball-screw preload)	N	T (roll pushing force)	N	Dr1 (drive-side roll diameter)	mm	Dr2 (follower-side roll diameter)	mm			Lr1 (drive-side roll length)	mm	Lr2 (follower-side roll length)	mm	G (reduction ratio)		JG (speed-reducer inertia)	kg·m ²	JC (coupling inertia)	kg·m ²			JN (nut inertia)	kg·m ²	JO (other motor-axis conversion inertia)	kg·m ²			Db (ball-screw diameter)	mm	Lb (ball-screw axial length)	mm	Pb (ball-screw lead)	mm	Dp (pinion/pulley diameter)	mm	Lp (pinion axial length)	mm	Tp (pulley thickness)	mm	Dt (table diameter)	mm	Dh (table-support diameter)	mm	LW (load shift from axis)	mm	Ds (table shaft diameter)	mm	Ls (table shaft length)	mm			ρ (specific gravity of ball-screw/pinion/pulley/table-shaft material)			kg/cm ³			μ (friction coefficient between sheet and sliding-surface/support-section/roll)		ρ1 (specific gravity of roll-1 material)			kg/cm ³	ρ2 (specific gravity of roll-2 material)		κ (internal friction coefficient of preload nut)				η (mechanical efficiency)		JL (load inertia of motor-axis conversion)			kg·m ²	TF (friction torque of motor axis conversion)		N·m		TU (imbalance torque of motor axis conversion)	N·m
WT (table mass)	kg	WL (work mass)	kg	WA (mass of other drive parts)	kg																																																																																												
WR (rack mass)	kg	WB (belt/chain mass)	kg	WC (counterbalance mass)	kg																																																																																												
Fa (external force in axial direction)	N	Fb (ball-screw preload)	N	T (roll pushing force)	N																																																																																												
Dr1 (drive-side roll diameter)	mm	Dr2 (follower-side roll diameter)	mm																																																																																														
Lr1 (drive-side roll length)	mm	Lr2 (follower-side roll length)	mm	G (reduction ratio)																																																																																													
JG (speed-reducer inertia)	kg·m ²	JC (coupling inertia)	kg·m ²																																																																																														
JN (nut inertia)	kg·m ²	JO (other motor-axis conversion inertia)	kg·m ²																																																																																														
Db (ball-screw diameter)	mm	Lb (ball-screw axial length)	mm	Pb (ball-screw lead)	mm																																																																																												
Dp (pinion/pulley diameter)	mm	Lp (pinion axial length)	mm	Tp (pulley thickness)	mm																																																																																												
Dt (table diameter)	mm	Dh (table-support diameter)	mm	LW (load shift from axis)	mm																																																																																												
Ds (table shaft diameter)	mm	Ls (table shaft length)	mm																																																																																														
ρ (specific gravity of ball-screw/pinion/pulley/table-shaft material)			kg/cm ³																																																																																														
μ (friction coefficient between sheet and sliding-surface/support-section/roll)		ρ1 (specific gravity of roll-1 material)			kg/cm ³																																																																																												
ρ2 (specific gravity of roll-2 material)		κ (internal friction coefficient of preload nut)																																																																																															
η (mechanical efficiency)		JL (load inertia of motor-axis conversion)			kg·m ²																																																																																												
TF (friction torque of motor axis conversion)		N·m		TU (imbalance torque of motor axis conversion)	N·m																																																																																												
8	Speed reducer Customer-provided (/); Sanyo standard (planet/spur/no-backlash-planet:: /); other (/)																																																																																																
9	Sensor type Sensor type specified (yes / no) Yes: (incremental , optical absolute , optical absolute [resolver absolute with incremental function]) Resolution ()																																																																																																
10	Input format Position , speed, torque, communications (SERCOS / CAN / DeviceNet) other ()																																																																																																
11	Upper-level equipment (controller) Sequencer , laptop , customer-developed product , Sanyo-provided , other ()																																																																																																
12	Usage environment and other requirements Cutting , clean-room use , anti-dust measures , other ()																																																																																																
13	Estimated production Single product: () units/month () units/year																																																																																																
14	Development schedule Prototype period: ()Year ()Month Production period: ()Year ()Month																																																																																																
15	Various measures Related documentation (already submitted ; send later by mail) Visit/PR desired (yes / no) Meeting desired (yes / no)																																																																																																
16	Miscellaneous (questions, pending problems, unresolved issues, etc.)																																																																																																

■ Precautions For Adoption

Cautions

Failure to follow the precautions on the right may cause moderate injury and property damage, or in some circumstances, could lead to a serious accident. Always follow all listed precautions.

Cautions

- Read the accompanying Instruction Manual carefully prior to using the product.
- If applying to medical devices and other equipment affecting people's lives, please contact us beforehand and take appropriate safety measures.
- If applying to equipment that can have significant effects on society and the general public, please contact us beforehand.
- Do not use this product in an environment where vibration is present, such as in a moving vehicle or shipping vessel.
- Do not perform any retrofitting, re-engineering, or modification to this equipment.
- The drivers and motors presented in this catalog are meant to be used for general industrial applications. If using for special applications related to aviation and space, nuclear power, electric power, submarine repeaters, etc., please contact us beforehand.

* For any question or inquiry regarding the above, contact our Sales Department.

SANYO DENKI CO., LTD.

1-15-1, Kita-Otsuka, Toshima-ku, Tokyo 170-8451, Japan

<http://www.sanyodenki.co.jp>

Phone: +81 3 3917 5157

SANYO DENKI AMERICA, INC.

468 Amapola Avenue Torrance, CA 90501 U.S.A.

Phone: +1 310 783 5400

SANYO DENKI EUROPE SA.

P.A. Paris Nord II 48 Allee des Erables-VILLEPINTE BP.57286 F-95958 ROISSY CDG Cedex France

Phone: +33 1 48 63 26 61

SANYO DENKI GERMANY GmbH

Frankfurter Strasse 63-69 65760 Eschborn Germany

Phone: +49 6196 76113 0

SANYO DENKI KOREA CO., LTD.

9F 5-2, Sunwha-dong Jung-gu Seoul, 100-130, Korea

Phone: +82 2 773 5623

SANYO DENKI SHANGHAI CO., LTD.

Room 2116, Bldg B, FAR EAST INTERNATIONAL PLAZA, No.317 XianXia Rd., Shanghai 200051 China

Phone: +86 21 6235 1107

SANYO DENKI TAIWAN CO., LTD.

Room 1208, 12F, No.96 Chung Shan N, Rd., Sec.2, Taipei 104, Taiwan, R.O.C.

Phone: +886 2 2511 3938

SANYO DENKI (H.K.) CO., LIMITED

Room 2305, 23/F, South Tower, Concordia Plaza, 1 Science Museum Rd., TST East, Kowloon, Hong Kong

Phone: +852 2312 6250

SANYO DENKI SINGAPORE PTE. LTD.

10 Hoe Chiang Road #14-03A/04 Keppel Towers Singapore 089315

Phone: +65 6223 1071

The names of companies and/or their products specified in this catalogue are the trade names, and/or trademarks and/or registered trademarks of such respective companies.
*Remarks : Specifications Are Subject To Change Without Notice.

CATALOG No. 833-3 '07.11.C